



## 24VDC-220VDC Inverters for industrial backup systems



24V      48/60V      110/125V      220/230V

**Modular power conversion architecture 1-24kVA**  
**1-phase and 3-phase secured AC supply**  
**True redundant n+1 system, hot swap modules**  
**Natural cooled and fan cooled modules**

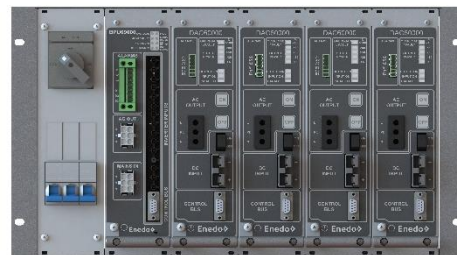

- Modular systems and stand-alone inverters
- 6kVA and 30kVA bypass units
- RS-232 access for local parameters
- Double battery bank supply solutions for power transmission backup systems
- On-line/Off-line configuration
- Complete systems solutions
- AC-distribution
- Relays and SNMP for remote monitoring

## PARALLEL CONNECTABLE INVERTER MODULES

Type	Nominal DC input	DC input Range	Nominal AC output	Nominal Power	Cooling	Dimensions Without handles	Weight
DAC62132VF	24VDC	20...32VDC	230VAC, 50Hz	1000VA/600W	Convection	14TE x 6U x 372mm	4 kg
DAC62232VF	24VDC	20...32VDC	230VAC, 50Hz	1200VA/800W	Forced, fan	14TE x 6U x 372mm	4 kg
DAC62134VF	48/60VDC	40...72VDC	230VAC, 50Hz	1000VA/700W	Convection	14TE x 6U x 372mm	4 kg
DAC62234VF	48/60VDC	40...72VDC	230VAC, 50Hz	1200VA/1200W	Forced, fan	14TE x 6U x 372mm	4 kg
DAC62135VF	110/125VDC	88...150VDC	230VAC, 50Hz	1000VA/700W	Convection	14TE x 6U x 372mm	4 kg
DAC62235VF	110/125VDC	88...150VDC	230VAC, 50Hz	1200VA/1200W	Forced, fan	14TE x 6U x 372mm	4 kg
DAC62136VF	220/230VDC	178...275VDC	230VAC, 50Hz	1000VA/700W	Convection	14TE x 6U x 372mm	4 kg
DAC62236VF	220/230VDC	178...275VDC	230VAC, 50Hz	1200VA/1200W	Forced, fan	14TE x 6U x 372mm	4 kg

## 19" 2U MECHANICAL ADAPTERS FOR HORIZONTAL INSTALLATION

MSR7990 + DAC type	1200VA fan cooled inverter in 19" 2U installation
ADU68230 + DAC type	1200VA fan cooled inverter and AC-distribution (4 x MCB) in 19" 2U installation

## STATIC SWITCH + MANUAL BYPASS

BPU69130VF	External static switch, 6000VA 230VAC, 14TE x 6U x 372mm module
MSR7990+BPU69130VF	External static switch, 6000VA 230VAC, 19" x 2U x 372mm
BPU69430FR + MBP68400	External static switch and manual bypass, 30kVA 230VAC, 19" x 3U x 480mm
MBP68000 / MBP68200	See separate datasheets for 6U and 2U manual bypass solutions

## ACCESSORIES

MSR7990	19" 2U adapter for 6U 14TE inverter and static switch modules
WMA7830	Wall mounting adapter for 6U 14TE inverter, 1-3 modules can be mounted to one compact package
68200014	19" Sub rack 6U 300mm for 1-6pcs of 14TE 6U models (note inverter's depth 372mm)
88680001	19" Sub rack 7U 300mm for 1-6pcs of 14TE 6U models including parallel connection cables
88680000	Wall mountable 19" Sub rack 7U 475mm for 1-6pcs of 14TE 6U models, shielded enclosure
88600000	Cover plate set for empty module place in 19" 6U sub rack
8760038	Communication system bus cable for 1...6 modules
876003H	Communication system bus cable for 1...12 modules
8760037	RS232 computer cable for inverters or 6kVA STS, D9 pins (includes Remote monitoring software in CD)
8781832	RS232 computer cable for 30kVA STS, D15 pins (includes Remote monitoring software in CD)
8781836	Communication adapter cable between inverter system bus D9 connector and 30kVA STS D15 connector
8760039	Power cable between 6kVA static switch and inverter

## AC-DISTRIBUTION

See separate datasheets for AC-distribution solutions

**The Inverter packing includes following:**

- 1) Inverter
- 2) AC output connector (finger protected screw terminals)
- 3) DC input cable 3m 2.5mm<sup>2</sup>-10mm<sup>2</sup>
- 4) User manual
- 5) Grounding cable 3m 6-10mm<sup>2</sup>

**The Static Switch packing includes:**

- 6) Static Switch
- 7) Mains Input cable 2m 4,5 mm<sup>2</sup>
- 8) AC output cable 2m 4,5 mm<sup>2</sup>
- 9) Grounding cable 2m 6mm<sup>2</sup>

**To be ordered separately**

- 10) RemoteMonitor software and Remote monitoring cable PC-Inverter(s)
- 11) Communication system bus cable
- 12) Power cable static switch – inverters 1m 1,5 mm<sup>2</sup>

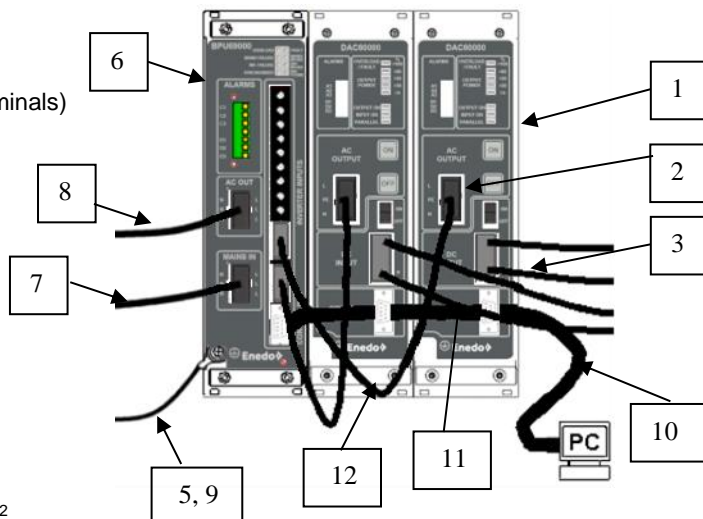

SPECIFICATION	24VDC		48/60VDC		110/125VDC		220/230VDC	
	1000VA	1200VA	1000VA	1200VA	1000VA	1200VA	1000VA	1200VA
<b>ELECTRICAL</b>								
Input voltage	20-32 VDC		40-72 VDC		88-150 VDC		178-275 VDC	
	User programmable (PC/RS-232) start-up and shut down voltage limits and delays							
Input current, max continuous	37 A	50 A	22 A	35 A	10 A	16 A	5 A	8 A
Input current, max 5 sec peak	75 A	75 A	50 A	50 A	22 A	22 A	11 A	11 A
Inrush current	< 30 A		< 20 A		< 10 A		< 10 A	
Output voltage	Nominal 230 VAC sine wave, user programmable 200-240V, floating output							
Output frequency	Nominal 50 Hz, user programmable 40 - 70 Hz, crystal locked							
Nominal output power	1000VA / 600W	1200VA / 800W	1000V A / 700W	1200VA / 1200W	1000V A / 700W	1200VA / 1200W	1000VA / 700W	1200VA / 1200W
Overload, 5 seconds	1200 W		1700 W		1700 W		1700 W	
Overload, 60 seconds	110% for all models, max time can be limited shorter Number of restart attempts and delays are user programmable							
Output current, nominal	4.4 A	5.2 A	4.4 A	5.2 A	4.4 A	5.2 A	4.4 A	5.2 A
Max short circuit current, 5 sec	13 A	13 A	13 A	13 A	13 A	13 A	13 A	13 A
Efficiency	85 %	83 %	90 %		90 %		90 %	
Load power factor range	Full power rating from 100% inductive to 100% capacitive							
Total harmonic distortion, resistive load	< 2 %							
Crest factor	> 3	> 2.7	> 3	> 2.7	> 3	> 2.7	> 3	> 2.7
Static regulation, 0...100% load	3%							
Transient recovery	< 0.3 ms							
Psfometric noise, input	N/A		< 2 mV		N/A		N/A	
Isolation	Input-Chassis 1500 VAC (2000 VCD) Input-Output 3000 VAC (4000 VDC) Output-Chassis 1500 VAC (2000 VDC)							
Protection	Output current limiting Overload and short circuit proof Internal input and output fuses							
DC input fuse (external fuse needed)	max C 63A		max C 40A		max C 25A		max C 16A	
Minimum grounding wire thickness	10mm <sup>2</sup>		6mm <sup>2</sup>		6mm <sup>2</sup>		6mm <sup>2</sup>	
Minimum DC input wire thickness	10mm <sup>2</sup>		6mm <sup>2</sup>		6mm <sup>2</sup>		2.5mm <sup>2</sup>	

STANDARDS	
Safety	EN62368-1:2014
EMC	EN61000-6-4:2006, EN61000-6-2:2007 + A1:2011 Static Switch: As inverters except immunity: EN61000-4-3 radiated immunity according to EN61000-6-1, other immunity standards EN61000-6-2
ALARMS, INDICATIONS AND CONTROLS	
LED-Indications	Input ON Output ON Output loading, 4 levels: >5%, >30%, >50%, >80% Overload / Fault
Relay alarms	2 relay contacts: Fault in system summary alarm (module failure, DC input low etc) Primary supply failure (system with bypass) or Output ON indication (system without bypass) Relay contact ratings: 24-48VDC: 60VDC/1A, 110VDC: 125VDC/0.4A, 220VDC: 250VDC/0.2A
Remote monitoring through RS-232 (Remote monitoring software)	Status information: For example, input and output voltage, power, temperature, faults etc. Parameter adjustment: For example, input voltage limits, output voltage, overload, faults etc.
MECHANICAL	
Dimensions	See first page
Connectors in front panel	Input DC connector: Anderson SB506331 G4 Output: Finger protected AC-connector, Wieland ST18/3S2
Enclosure	Steel casing IP20

	24VDC		48/60VDC		110/125VDC		220/230VDC	
	1000VA	1200VA	1000VA	1200VA	1000VA	1200VA	1000VA	1200VA
Operating temperature / Humidity	0...+40 °C full power		0...+40 °C full power		-10...+40 °C full power		-10...+40 °C full power	
	+40...+60 °C reduced power, derating -2%/C typically, no condensation							
Cooling (Fans are redundant and monitored)	Natural convection	Fan cooling	Natural convection	Fan cooling	Natural convection	Fan cooling	Natural convection	Fan cooling
Altitude	Full power up to 2000m, derating -2% / 100m, max altitude 3000m							

## CONFIGURATIONS & SYSTEM ARCHITECTURES

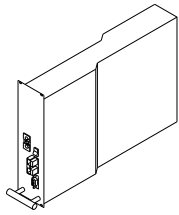

Stand-alone

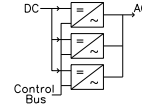
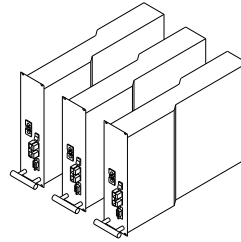

Parallel

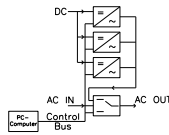
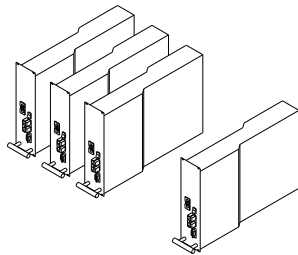

Parallel with external static switch

## SPECIAL SYSTEMS

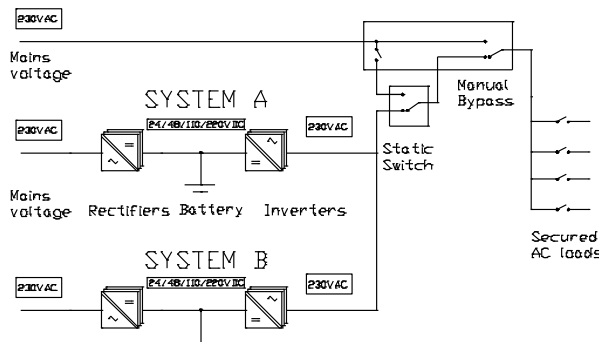

Dual Redundant  
Double battery system

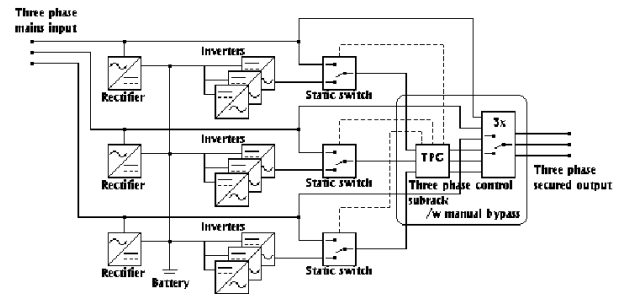

3-phase system  
Same inverter modules

## EXPANDING SYSTEM

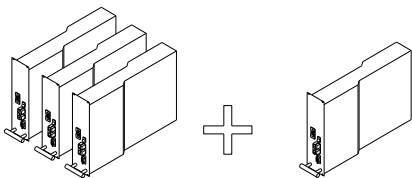

### More power needed or unit replacement

No need to shut down system output

1) Connect cables: DC cable, AC cable, System bus

2) Turn new unit on

- Automatically enters system
- Automatically adapts system parameters (voltage, frequency etc.)
- Automatically turns output on if the system output is on



- MCB distribution panels, Schuko outlets
- IEC320 outlets
- Customized inverter system configurations

## REMOTE MONITORING AND SNMP

Units	Status	Last event	Faults	Output (W)	Output (VA)	Output (A)	Loading	Output (V)	Output (Hz)	Input (V)	Input (A)	Si temp (°C)	Site
System	On default supply	-	-	1740 W	1770 VA	7.6 A	82 %	220 V	50.0 Hz	51.6 V	30 A	59 °C/138 °F	58 °C/134 °F
Unit 1	Output on	Output switched on	-	580 W	580 VA	2.5 A	82 %	220 V	50.0 Hz	51.6 V	13 A	60 °C/140 °F	57 °C/135 °F
Unit 2	Output on	Output switched on	-	580 W	580 VA	2.5 A	82 %	220 V	50.0 Hz	51.6 V	13 A	58 °C/136 °F	56 °C/133 °F
Unit 3	Output on	Output switched on	-	580 W	600 VA	2.6 A	83 %	220 V	50.0 Hz	51.6 V	13 A	58 °C/136 °F	56 °C/133 °F

Bypass	Status	Last event	General faults	AC supply (V)	Invert.	Inverte.	Main (V)	Main (Hz)	Output	Output	Output	Output	Si temp	Leak
Bypass	On inverter	Switched to inverters	-	220 V	50.0 Hz	215 V	50.0 Hz	228 V	8 A	1.71 kW	1.81 VA	27 °C/80 °F	-	

Continuous status information from all units:

- Output on/standby, voltage, current, power, loading per cent
- Input voltage and current, Internal temperatures, faults

Parameter adjustment (without turning system output off):

- Inverter start up and shut down input voltage limits, reaction delays
- Output voltage and frequency, number of restart attempts
- Bypass synchronizing frequency range, accepted voltage ranges etc.

## SYSTEM AVAILABILITY

Real redundancy - No single failure may fail the system

No external controller

- No other master slave dependence but synchronising
- If synchronising master fails, next unit starts sending the synchronising data

Rugged system bus structure with galvanic isolation

Automatic bus address configuring

- No need for address setup by user
- No malfunctions because of wrong setup

Self tests and diagnostics

- Full automatic power stage test every time inverter is started
- Continuous monitoring of internal operations
- Error counters (RS-232) for troubleshooting
- Recognising of wrong connections (cable not connected, wrong AC bus polarity)

Recovery and monitoring procedures in hardware and software

- Stands disturbances in system bus
- Stands accidental system bus disconnecting for seconds
- Stands wrong connections of cables
- If one unit fails other units alarm
- Voting procedures for recognising and filtering wrong operation

Automatic fast shut down of failed unit

- Disconnecting from AC bus in 10 ms
- Automatic watch dog restart if processor hangs up
- Unit automatically turns output off if synchronising lost for too long time

Internal history file in each inverter, last 30-40 system and unit specific events