



CFM70S SERIES 70 WATT OPEN FRAME AC-DC MODULES

Features

- Universal Input Range 85~264Vac
- High Efficiency up to 91%
- 2"x 3" Open Frame Compact Size
- Class I and Class II
- No Load Input Power < 0.15W
- Approval IEC/EN/UL 62368-1 Ed 3.0
- Meets IEC/EN 60335-1
- Approval EN 55032 Class B and CISPR/FCC Class B
- Operating Altitude 5000m
- Continuous Short Circuit Protection
- Over Voltage Protection
- Over Voltage Category OVC II & OVC III



| MODEL NUMBER | OUTPUT VOLTAGE | OUTPUT CURRENT | VOLTAGE ACCURACY NOTE1 | RIPPLE& NOISE NOTE2 | LINE REGULATION NOTE3 | LOAD REGULATION NOTE4 | %EFF. (Typ.) NOTE5 |
|--------------|----------------|----------------|------------------------|---------------------|-----------------------|-----------------------|--------------------|
| CFM70S050 | 5 V | 10.0 A | ±2% | 150 mV | ±0.5% | ±1% | 86% |
| CFM70S120 | 12 V | 5.80 A | ±2% | 120 mV | ±0.5% | ±1% | 90% |
| CFM70S150 | 15 V | 4.65 A | ±1% | 150 mV | ±0.5% | ±1% | 90% |
| CFM70S240 | 24 V | 2.92 A | ±1% | 240 mV | ±0.5% | ±1% | 90% |
| CFM70S360 | 36 V | 1.94 A | ±1% | 360 mV | ±0.5% | ±1% | 90% |
| CFM70S480 | 48 V | 1.46 A | ±1% | 480 mV | ±0.5% | ±1% | 91% |

Note:

1. Voltage accuracy is set at 100% full load.
2. Add a 0.1uF ceramic capacitor and a 10uF E.L. capacitor to output for ripple & noise measurement @20MHz BW.
3. Line regulation is measured from 90V_{ac} to 264V_{ac} with 100% full load.
4. Load regulation is measured from 10% to full load.
5. Typical efficiency at 230 V_{ac}.
6. Standard input and output connectors (CN1 and CN2) wafer with TAIWAN KING PIN TERMINAL PVHI series and mate with JST housing VHR series and JST SVH-41T-P1.1 series crimp terminal and output connectors wire 16AWG.

PART NUMBER

| Series | Number of Outputs | Nominal Output Voltage | Type |
|--------|-------------------|--|--|
| CFM70 | O | XX | -X (Option) |
| CFM70 | S : Single | 050 : 05V 120 : 12V 150 : 15V 240 : 24V 360 : 36V 480 : 48V | None : Wafer P : PCB Mount CA : Cover E : Encapsulated S : Terminal Block SD : Terminal Block with Din rail |

Part Number Example:

CFM70S120: Open Frame, 70W, Single 12V_{dc} Output



CFM70S Series

TECHNICAL SPECIFICATIONS

(All specifications are typical at nominal input, full load at 25°C unless otherwise noted.)

ABSOLUTE MAXIMUM RATINGS

| PARAMETER | NOTES and CONDITIONS | Device | Min. | Typ. | Max. | Units |
|-----------------------|--|--------|------|------|------|-----------------|
| Input Voltage | Safety approvals only to the AC input (DC input no safety) | All | 85 | | 264 | V _{ac} |
| | | | 120 | | 370 | V _{dc} |
| Operating Temperature | See Derating Curve | All | -30 | | 80 | °C |
| Storage Temperature | | All | -30 | | 85 | °C |
| Operating Altitude | IEC/EN/UL 62368-1 OVC II | All | | | 5000 | m |
| | IEC/EN 62368-1 OVC III | | | | 2000 | |
| | Meets IEC/EN 60335-1 OVC II | | | | 3000 | |

INPUT CHARACTERISTICS

| PARAMETER | NOTES and CONDITIONS | Device | Min. | Typ. | Max. | Units |
|-------------------------|--|--------|------|------|------|-----------------|
| Operating Voltage Range | | All | 100 | | 240 | V _{ac} |
| Input Frequency Range | | All | 50 | | 60 | Hz |
| Maximum Input Current | 100% Load, V _{in} =100V _{ac} | All | | | 1.5 | A |
| Leakage Current | | All | | | 0.1 | mA |
| Inrush Current | V _{in} =240V _{ac} , Cold start at 25°C | All | | 130 | | A |

OUTPUT CHARACTERISTICS

| PARAMETER | NOTES and CONDITIONS | Device | Min. | Typ. | Max. | Units |
|--------------------------------|--|-----------|-------|------|-------|-----------------|
| Output Voltage Set Point | V _{in} =Nominal V _{in} , I _o =I _o max., T _c =25°C | CFM70S050 | 4.90 | 5 | 5.10 | V _{dc} |
| | | CFM70S120 | 11.76 | 12 | 12.24 | |
| | | CFM70S150 | 14.85 | 15 | 15.15 | |
| | | CFM70S240 | 23.76 | 24 | 24.24 | |
| | | CFM70S360 | 35.64 | 36 | 36.36 | |
| | | CFM70S480 | 47.52 | 48 | 48.48 | |
| Operating Output Current Range | V _{in} =115V _{ac} and 230V _{ac} , T _c =25°C | CFM70S050 | | | 10.0 | A |
| | | CFM70S120 | | | 5.80 | |
| | | CFM70S150 | | | 4.65 | |
| | | CFM70S240 | | | 2.92 | |
| | | CFM70S360 | | | 1.94 | |
| | | CFM70S480 | | | 1.46 | |
| Holdup Time | V _{in} =115V _{ac} | All | | 10 | | ms |
| Output Voltage Regulation | | | | | | |
| Load Regulation | 10% Load to full load | All | | | ±1.0 | % |
| Line Regulation | V _{in} =High line to low line | All | | | ±0.5 | % |
| Over Voltage Protection | Hiccup mode (Auto recovery) | CFM70S050 | | | 6.3 | V _{dc} |
| | | CFM70S120 | | | 15.6 | |
| | | CFM70S150 | | | 18.0 | |
| | | CFM70S240 | | | 29.1 | |
| | | CFM70S360 | | | 43.3 | |
| | | CFM70S480 | | | 56.8 | |
| Over Current Protection | Hiccup mode (Auto recovery) | All | 110 | | 140 | % |
| Short Circuit Protection | Hiccup mode (Auto recovery) | All | | | | |



CFM70S Series

| PARAMETER | NOTES and CONDITIONS | Device | Min. | Typ. | Max. | Units |
|-------------------------|---|-----------|------|------|-------|-------|
| Output Ripple and Noise | 1. Add a 0.1uF ceramic capacitor and a 10uF aluminum electrolytic capacitor to output 2. Oscilloscope is 20MHz band width 3. Ambient Temperature=25°C | CFM70S050 | | | 150 | mV |
| | | CFM70S120 | | | 120 | |
| | | CFM70S150 | | | 150 | |
| | | CFM70S240 | | | 240 | |
| | | CFM70S360 | | | 360 | |
| | | CFM70S480 | | | 480 | |
| Load Capacitance | 1. $V_{in}=115V_{ac}$ and $230V_{ac}$ 2. Output is max. load 3. Ambient temperature=25°C | CFM70S050 | | | 10300 | uF |
| | | CFM70S120 | | | 6000 | |
| | | CFM70S150 | | | 4700 | |
| | | CFM70S240 | | | 2920 | |
| | | CFM70S360 | | | 1980 | |
| | | CFM70S480 | | | 930 | |
| Efficiency | 1. Input voltage is $230V_{ac}$ 2. Output is rated load | CFM70S050 | | 86 | | % |
| | | CFM70S120 | | 90 | | |
| | | CFM70S150 | | 90 | | |
| | | CFM70S240 | | 90 | | |
| | | CFM70S360 | | 90 | | |
| | | CFM70S480 | | 91 | | |

ISOLATION CHARACTERISTICS

| PARAMETER | NOTES and CONDITIONS | Device | Min. | Typ. | Max. | Units |
|----------------------|----------------------|--------|------|------|------|----------|
| Input to Output | 1 Minute | All | | | 4250 | V_{ac} |
| Isolation Resistance | Input to output | All | 100 | | | MΩ |

FEATURE CHARACTERISTICS

| PARAMETER | NOTES and CONDITIONS | Device | Min. | Typ. | Max. | Units |
|---------------------|-----------------------|--------|------|------|------|-------|
| Switching Frequency | Pout=max. rated power | All | | 65 | | kHz |

GENERAL SPECIFICATIONS

| PARAMETER | NOTES and CONDITIONS | Device | Min. | Typ. | Max. | Units |
|------------|---|-----------|---|------|------|---------|
| MTBF | $I_o=100%$; $T_a=25^\circ C$ per MIL-HDBK-217F | All | 500 | | | k hours |
| Humidity | Non-condensing | All | | | 93 | % RH |
| Shock | Meet MIL-STD-810F Table 516.5, Table 516.5-I 10ms, each axis 3 times($\pm X$ 、 $\pm Y$ 、 $\pm Z$ axis) | All | | 75 | | g |
| Vibration | Meet MIL-STD-810F Table 514.5C-VIII, 15~2000Hz, X、Y、Z axis, 1 hour (each axis),. Total 3 hrs. | All | | 4 | | g |
| Weight | | CFM70S | | 96.1 | | grams |
| | | CFM70S-P | | 94.1 | | |
| | | CFM70S-CA | | 183 | | |
| | | CFM70S-E | | 223 | | |
| | | CFM70S-S | | 236 | | |
| | | CFM70S-SD | | 333 | | |
| Dimensions | Open Frame (Wafer) | All | 3.000x2.000x1.067 Inches (76.20x50.80x27.1 mm) | | | |
| | P (PCB Mount) | | 3.000x2.000x1.142 Inches (76.20x50.80x29mm) | | | |
| | CA (Cover) | | 3.598x2.520x1.358 Inches (91.40x64.00x34.50 mm) | | | |
| | E (Encapsulated) | | 2.170x3.140x1.201 Inches (55.20x79.80x30.50 mm) | | | |
| | S (Terminal Block) | | 2.170x4.200x1.201 Inches (55.20x106.60x30.50 mm) | | | |
| | SD (Din rail type) | | 2.170x4.200x1.783 Inches (55.20x106.60x45.30 mm) | | | |

CFM70S Series

GENERAL SPECIFICATIONS

| | | |
|--|---|-------------|
| Safety | Class I, Class II, IEC/EN/UL62368-1 | Ed 3.0 |
| EMC Emission | EN 55032: 2015+AC: 2016, 47 CFR FCC Part 15 Subpart B, EN 61000-3-2: 2019, EN 61000-3-3: 2013 | Class B |
| Conducted Disturbance | EN 55032, 47 CFR FCC Part 15 | Class B |
| Radiated Disturbance | EN 55032, 47 CFR FCC Part 15 | Class B |
| Harmonic Current Emissions | EN 61000-3-2:2019 | |
| Voltage Fluctuations & Flicker | EN 61000-3-3:2013 | |
| EMC Immunity | EN 55035:2017 | |
| Electrostatic Discharge (ESD) | IEC 61000-4-2:2008, Air Discharge: $\pm 8\text{kV}$, Contact Discharge: $\pm 4\text{kV}$ | Criterion A |
| Radio-Frequency, Continuous Radiated Disturbance | IEC 61000-4-3:2020 | Criterion A |
| Electrical Fast Transient (EFT) | IEC 61000-4-4:2012, $\pm 0.5\text{kV}$, $\pm 1\text{kV}$, $\pm 2\text{kV}$ | Criterion A |
| Surge | IEC61000-4-5:2014, L-N: $\pm 2\text{kV}$, L-E (Ground): $\pm 4\text{kV}$ | Criterion A |
| Conducted Disturbances, Induced by RF Fields | IEC 61000-4-6:2013 | Criterion A |
| Power Frequency Magnetic Field | IEC 61000-4-8:2009 | Criterion A |
| Voltage Dips | IEC 61000-4-11:2004, Dip: 30% Reduction, Dip >95% Reduction | Criterion A |
| Voltage Interruptions | IEC 61000-4-11:2004, >95% Reduction | Criterion B |
| Application Note Link | CFM70S Series App Notes | |

CHARACTERISTIC CURVE

Power Derating Curve

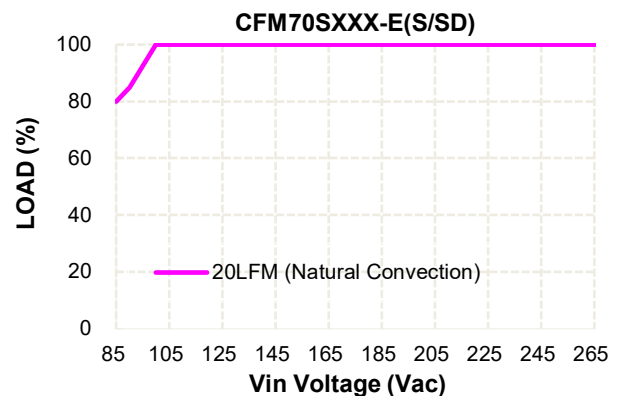
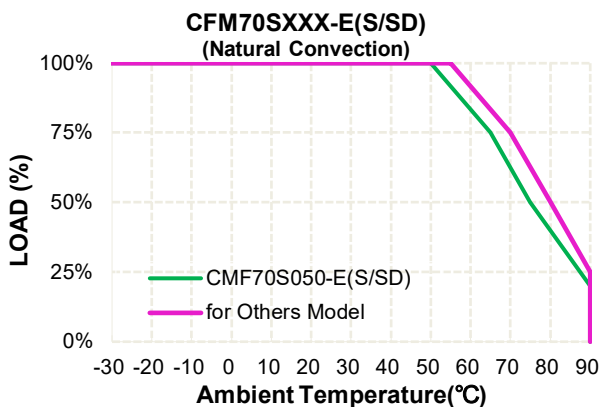
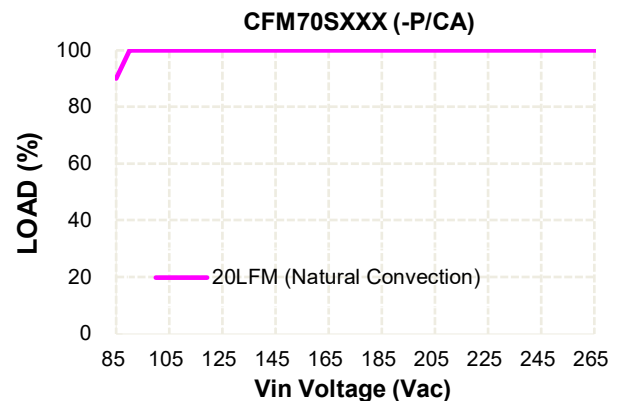
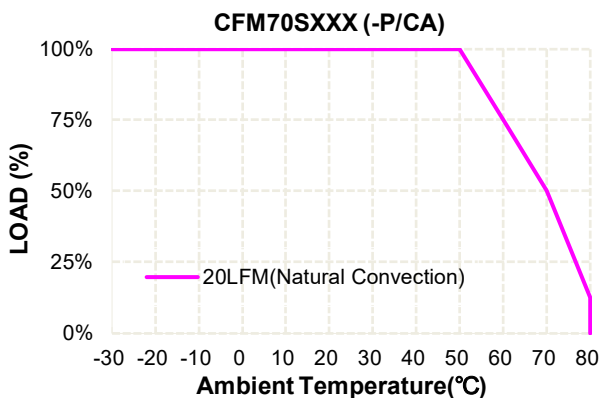



CFM70S Series

Performance Data

CFM70S050 (Eff Vs Io)

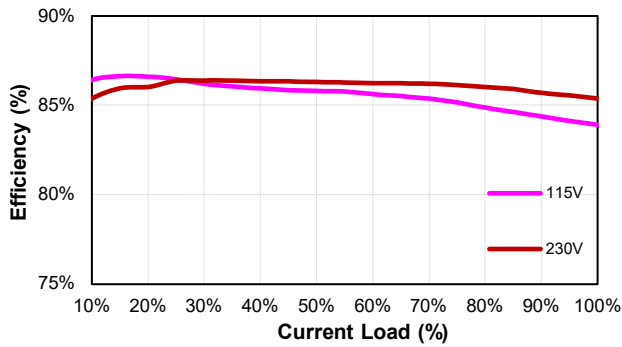

CFM70S120 (Eff Vs Io)

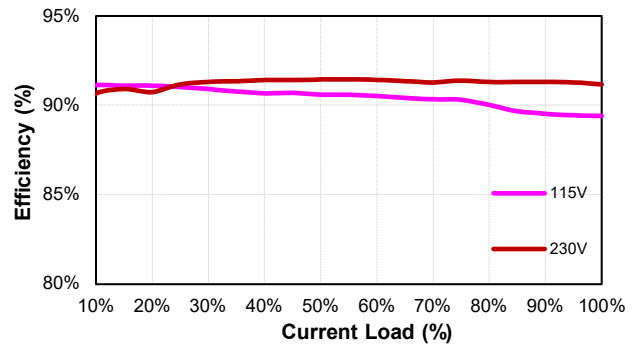

CFM70S150 (Eff Vs Io)

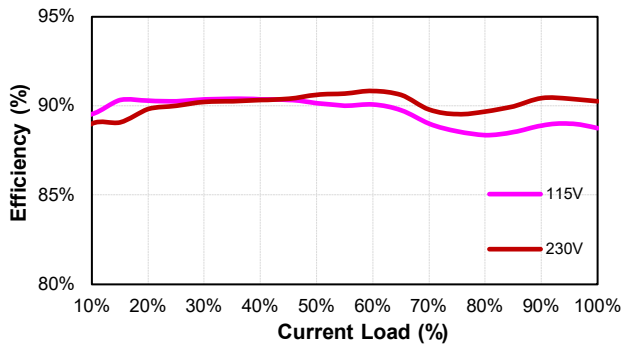

CFM70S240 (Eff Vs Io)

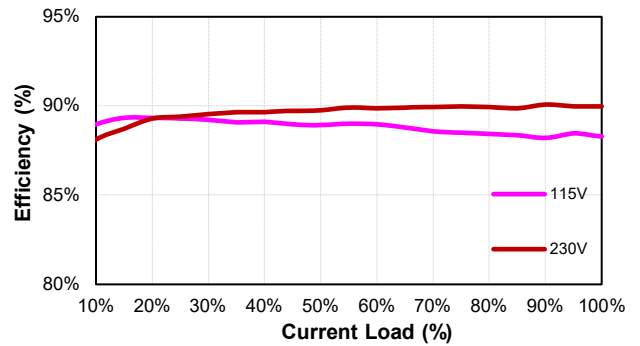

CFM70S360 (Eff Vs Io)

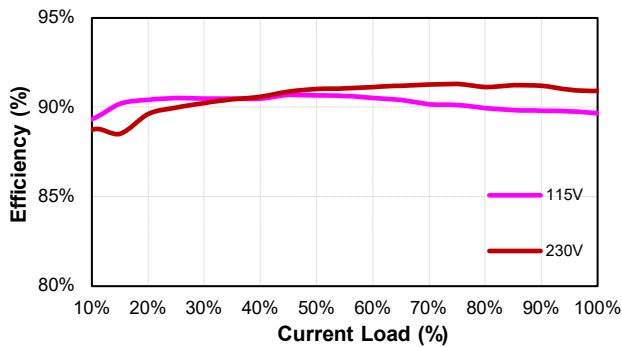

CFM70S480 (Eff Vs Io)

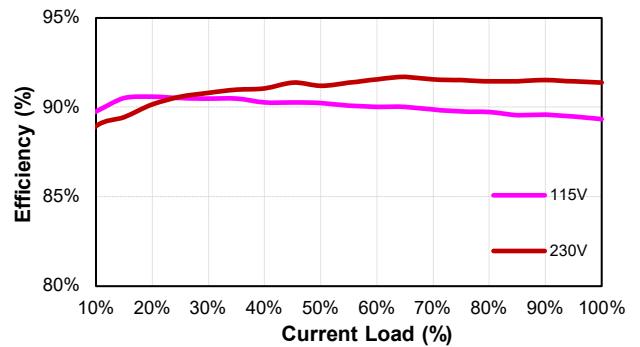

MECHANICAL SPECIFICATION

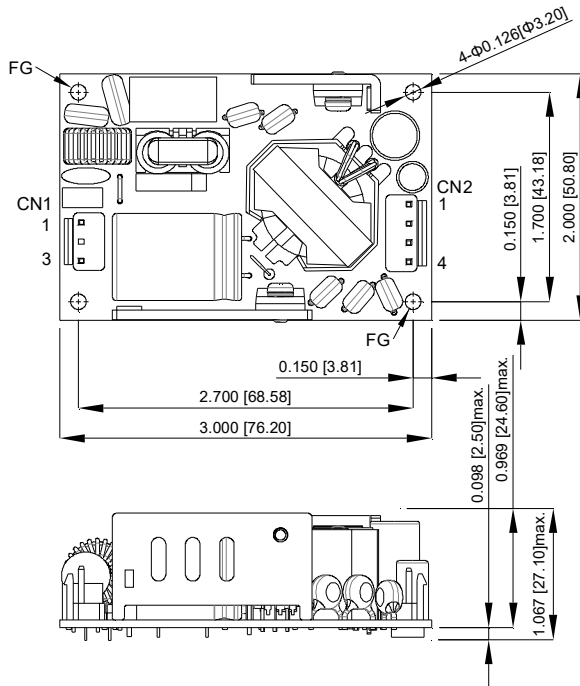

CFM70SXXX

AC Input Connector(CN1):TKP PVHI-03N2 or equivalent

| Pin | Function | Mating Housing | Terminal |
|-----|----------|--------------------------|--------------------------------|
| 1 | ACL | JST VHR-3N or equivalent | JST SVH-21T-P1.1 or equivalent |
| 2 | - | | |
| 3 | ACN | | |

DC Output Connector(CN2):TKP PVHI-04 or equivalent

| Pin | Function | Mating Housing | Terminal |
|-----|----------|--------------------------|--------------------------------|
| 1 | +Vout | JST VHR-4N or equivalent | JST SVH-21T-P1.1 or equivalent |
| 2 | +Vout | | |
| 3 | -Vout | | |
| 4 | -Vout | | |

All Dimensions in Inches[mm]
 Tolerance Inches : X.XXX=±0.02
 Millimeters : X.XX=±0.5

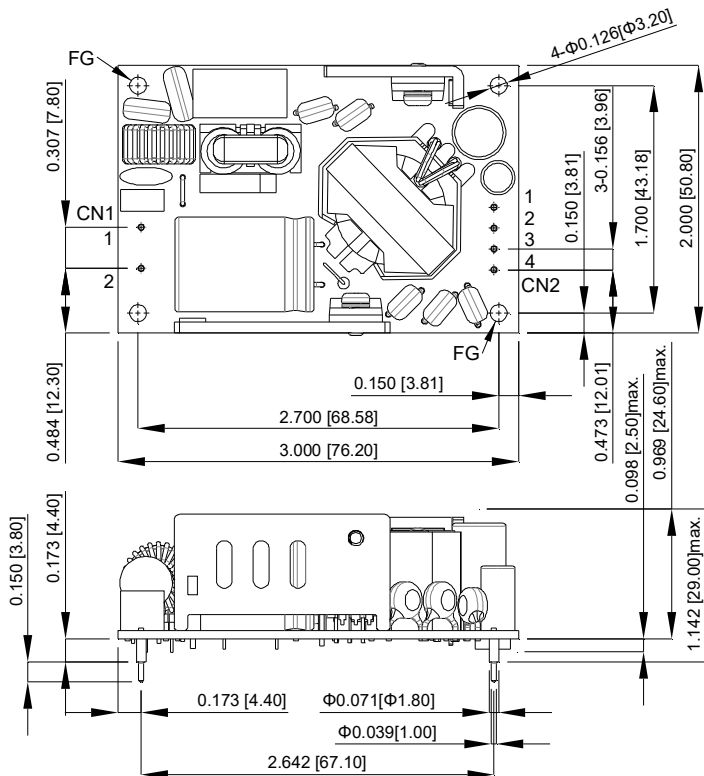

CFM70SXXX-P

CN1

| PIN CONNECTION | |
|----------------|----------|
| Pin | Function |
| 1 | ACL |
| 2 | ACN |

CN2

| PIN CONNECTION | |
|----------------|----------|
| Pin | Function |
| 1 | +Vout |
| 2 | +Vout |
| 3 | -Vout |
| 4 | -Vout |

All Dimensions in Inches[mm]
 Tolerance Inches : X.XXX=±0.02
 Millimeters : X.XX=±0.5

CFM70S Series

MECHANICAL SPECIFICATION

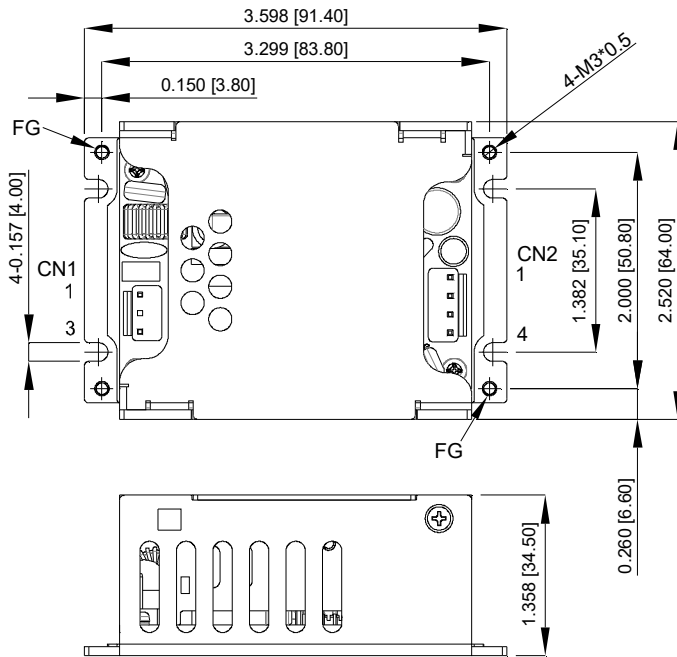

CFM70SXXX-CA

AC Input Connector(CN1):TKP PVHI-03N2 or equivalent

| Pin | Function | Mating Housing | Terminal |
|-----|----------|--------------------------|--------------------------------|
| 1 | ACL | JST VHR-3N or equivalent | JST SVH-21T-P1.1 or equivalent |
| 2 | - | | |
| 3 | ACN | | |

DC Output Connector(CN2):TKP PVHI-04 or equivalent

| Pin | Function | Mating Housing | Terminal |
|-----|----------|--------------------------|--------------------------------|
| 1 | +Vout | JST VHR-4N or equivalent | JST SVH-21T-P1.1 or equivalent |
| 2 | +Vout | | |
| 3 | -Vout | | |
| 4 | -Vout | | |

All Dimensions in Inches[mm]
Tolerance Inches : X.XXX=±0.02
Millimeters : X.XX=±0.5

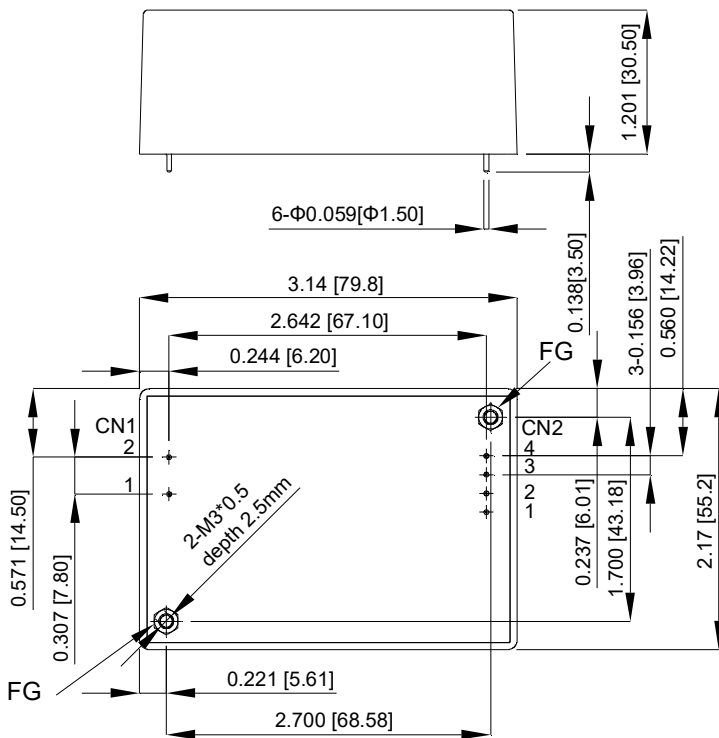

CFM70SXXX-E

| PIN CONNECTION | | |
|----------------|----------|-------|
| Pin | Function | Wafer |
| 1 | ACL | CN1 |
| 2 | ACN | |
| 1 | +Vout | CN2 |
| 2 | +Vout | |
| 3 | -Vout | |
| 4 | -Vout | |

All Dimensions in Inches[mm]
Tolerance Inches : x.xx=±0.03,x.xxx=±0.02
Millimeters : x.x=±0.7,x.xx=±0.5

MECHANICAL SPECIFICATION

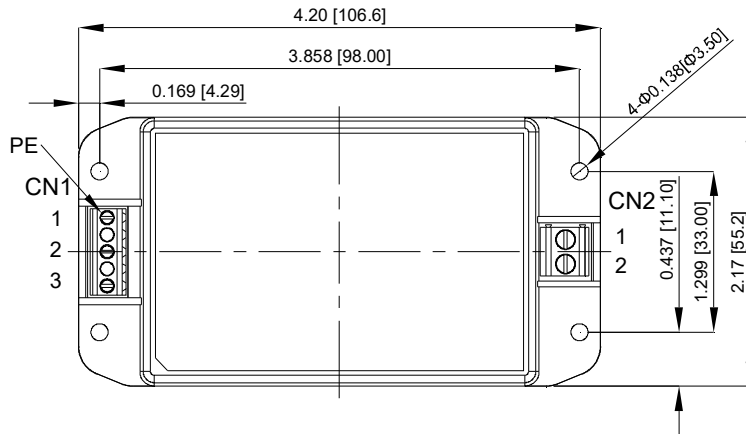

CFM70SXXX-S

AC Input Connector(CN1):DINKLE EK350V-03P5 or equivalent

| Pin | Function | Mating Wire Range |
|-----|----------|-------------------|
| 1 | PE | 16~30 AWG |
| 2 | ACL | |
| 3 | ACN | |

DC Output Connector(CN2):DINKLE EK500V-02P or equivalent

| Pin | Function | Mating Wire Range |
|-----|----------|-------------------|
| 1 | +Vout | 12~16 AWG |
| 2 | -Vout | |

All Dimensions in Inches[mm]
 Tolerance Inches: x.xx=±0.03, x.xxx=±0.020
 Millimeters: x.x=±0.7, x.xx=±0.50

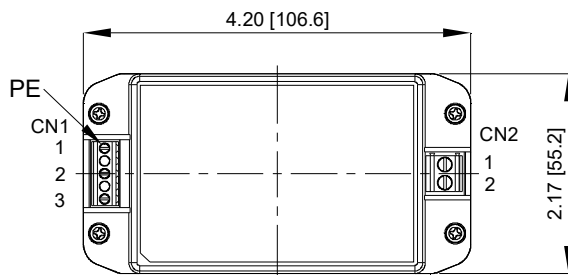

CFM70SXXX-SD

AC Input Connector(CN1):DINKLE EK350V-03P5 or equivalent

| Pin | Function | Mating Wire Range |
|-----|----------|-------------------|
| 1 | PE | 16~30 AWG |
| 2 | ACL | |
| 3 | ACN | |

DC Output Connector(CN2):DINKLE EK500V-02P or equivalent

| Pin | Function | Mating Wire Range |
|-----|----------|-------------------|
| 1 | +Vout | 12~16 AWG |
| 2 | -Vout | |

All Dimensions in Inches[mm]
 Tolerance Inches: x.xx=±0.03, x.xxx=±0.020
 Millimeters: x.x=±0.7, x.xx=±0.50

