

UL AC Plug Dimension(unit:mm)

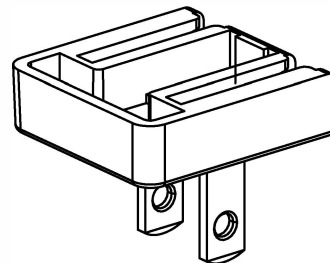
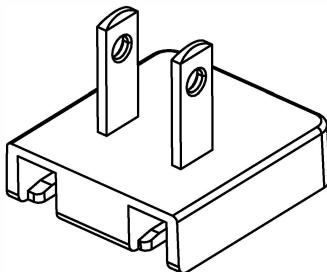
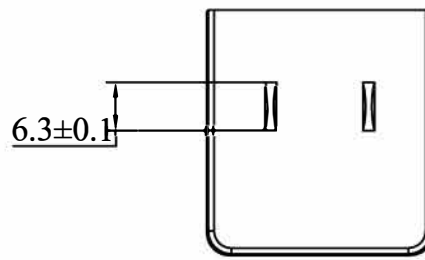
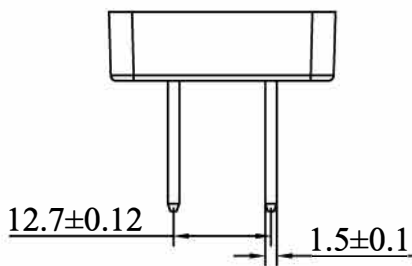
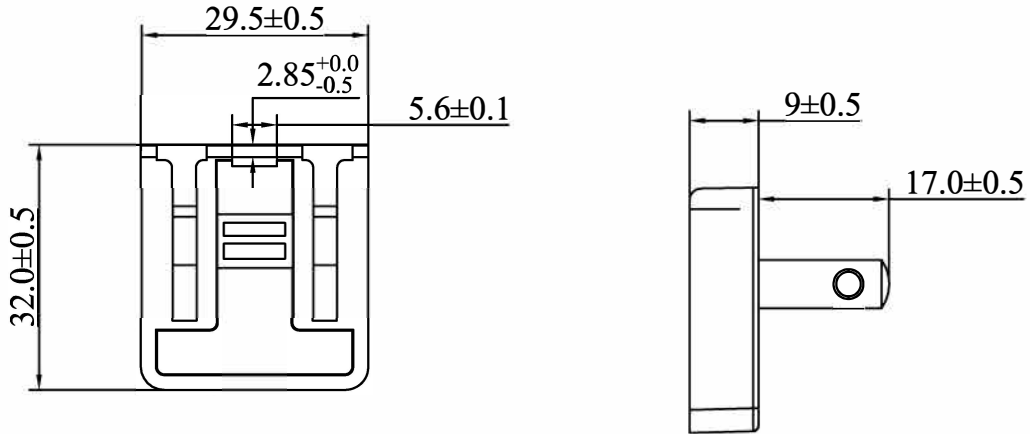

LCP-UL-A Plug Black RoHS+RAHS

300301032000(20100421)

Part No.: KT1001US

Package Method(unit:mm)

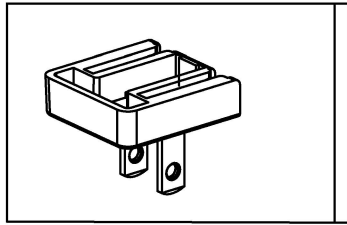

PE bag

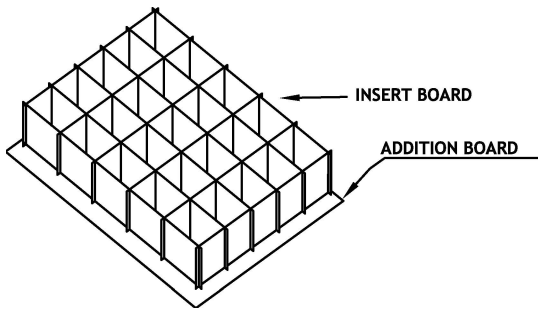

INSERT BOARD

ADDITION BOARD

Technical Requirement:

1. Carton: 2 layers wall, 6mm thickness.

Outline dimension: 540mm × 390mm × 276mm

2. Additional board:

3 mm thickness

3 pieces per carton.

3. Humidity protector:

Each plug packed in a small PE bag.

All boxes packed in a big PE bag with an outer carton.

4. Quantity:

2 layers per carton.

200 pcs. per layer.

400 pcs. per carton.

5. Weight:

Each carton approx. 5.6 kg gross.

Each carton approx. 3.4 kg net.

Side mark

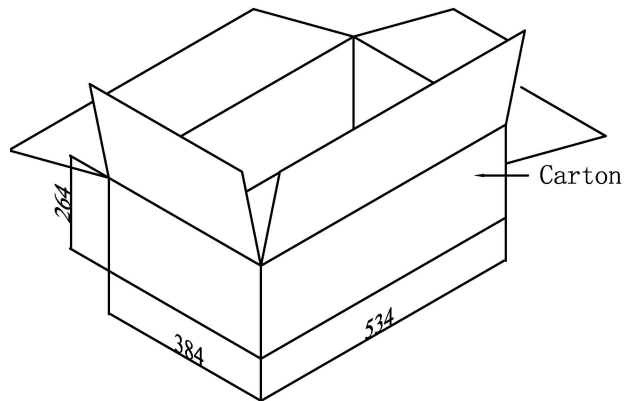

Carton



carton label position

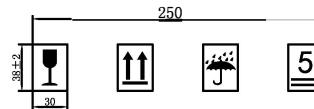

Front mark



MODEL No: _____ DATE CODE: _____
 DESCRIPTION: _____ S/N: _____ TO _____
 ORDER No: _____ QTY: _____
 VOLUME: 54.0x39.0x27.6(CM) WEIGHT: _____

SL Power Electronics Co.,Ltd

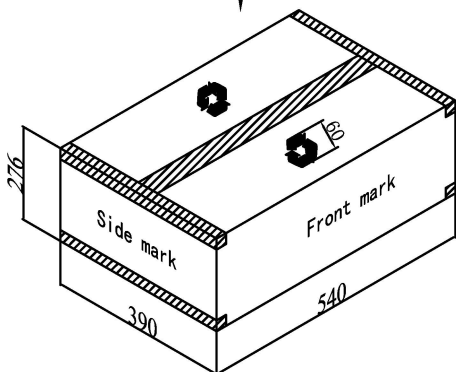

Side mark

Front mark

1. Words: SL Electronics Co.,Ltd. is Arial, 20mm high
Other words is Arial, 13mm high
2. Color: Recycle logo 60mm high, center position;
words & logo is black.