

## FEATURES AND APPLICATIONS

- Power LED Driver
- Constant Current Output ( $\pm 7\%$  Output Current Accuracy)
- Wide Input Voltage Range: 7V to 30V (40V for 0.5 sec)
- 16 Pin DIL Package
- LED Driver Current up to 600mA
- Output Power up to 17W
- Driver LED Strings of up to 28V (2V to 28V)
- RoHS ✓
- High Efficiency (up to 95%)
- PWM/Digital Dimming and Analog Voltage Dimming
- Open and Short LED Protection
- $-40^{\circ}\text{C}$  to  $85^{\circ}\text{C}$  Operation Temperature Range



- 12V and 24V Lighting Systems
- Household/Commercial lighting
- Suitable for high illumination LED
- Battery lighting systems

## GENERAL DESCRIPTION

The VLD-V30C600 is a high efficiency step-down converter optimized to drive high current LEDs. The control algorithm allows highly efficient and accurate LED current regulation. The device operates from an input of 7Vdc to 30Vdc and provides an externally adjustable output current of up to 600mA and output power up to 17 Watts. Compact size of DIL16 allows designer to integrate this driver together with LED module.

## DIL 16 Package

Notes : All dimensions are typical in millimeters ( inches ).

1. Pin diameter:  $0.5 \pm 0.05$  (  $0.02 \pm 0.002$  )
2. Pin pitch tolerance:  $\pm 0.35$  (  $\pm 0.014$  )
3. Case Tolerance:  $\pm 0.5$  (  $\pm 0.02$  )

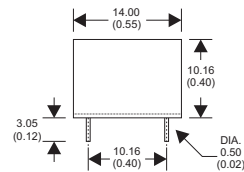
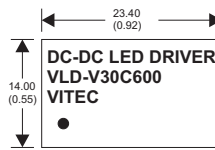

VLD-V30C600		
Pin	Connections	Note
1, 2	-V Input	-DC Supply
3	V adj	PWM/on/off or not used
7, 8	-V Output	LED Cathode Connection
9, 10	+V Output	LED Anode Connection
15, 16	+V Input	+DC Supply

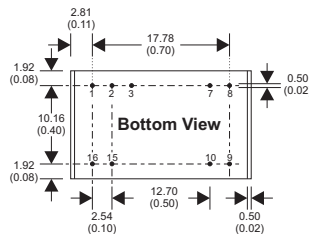

Recommended Footprint Details

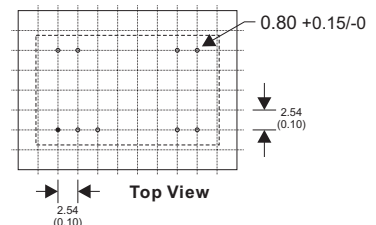

**No connection is allowed between input and output**

Notes:

Specifications can be changed without prior notice

Products are not intended for and must not be used in life support systems, human implantation, nuclear facilities or systems or any other application where product failure or malfunction of the component could lead to loss of life or catastrophic property damage

**ELECTRICAL SPECIFICATIONS**

Specifications typical at +25°C, nominal Input voltage, rated output current unless otherwise specified.

**Input Specifications**

Voltage Range	7Vdc to 30Vdc (40V for 0.5 sec)
Filter	Capacitor

**Output Specifications**

Voltage Range	2Vdc to 28V (Vin = 30Vdc)
Current Range	600mA (Vin - Vout > 2V to 3V)
Current Accuracy	±7% (Iout = 600mA)
Ripple and Noise (20 MHz BW)	250 mVp-p, max.
Short Circuit Protection	Regulated at Rated Output Current
Capacitive Load	47µF

**Environmental Specification**

Operating Temperature	-40°C to +85°C
Max. Case Temperature	+100°C
Storage Temperature	-40°C to +125°C
Thermal Impedance	+50°C/W (Nature Convection)
Cooling	Free-air convection
Temperature Coefficient	±0.05%/°C max. (Ta = -40°C to +85°C)

**Analog Dimming Control**

Leave Open if Not Used	
Vadj Input Voltage Range	0.3V to 1.25V
Adjust Output Current	25% to 100%
Control Voltage Range Limits	
On	0.2V to 0.3V
Off	0.15V to 0.25V
Analog Pin Drive Current	< 1mA (Vadj = 1.25V)

**PWM Dimming and On/Off Control**

Leave Open if Not Used	
Remote On/Off	
DC/DC On	Open or 0.3V < Vadj < 1.25V
DC/DC off (Shutdown)	Vadj < 0.15V
Remote Pin Drive Current	< 1mA (Vadj = 1.25V)
Quiescent Input Current in Shutdown Mode	25µA (max, Vin = 30V)

**PWM Dimming**

Recommended Maximum Operating Frequency	1kHz
Minimum Switch ON Time	200ns
Minimum Switch OFF Time	200ns

**General Specification**

Efficiency	95% max. (Full Load)
Switching Frequency	55 kHz to 320 kHz
Humidity	95% rel H
MTBF (MIL-HDBK-217 F)	> 4.7 Mhrs

**Physical Characteristics**

Dimension DIP	23.40 x 14.00 x 10.16 mm 0.92 x 0.55 x 0.40 inches
Weight	6.2 g
Case Material	Non-Conductive Black Plastic (UL94-V0 rated)
Potting Material	Epoxy (UL94-V0 rated)
Pin Material	∅ 0.5mm Brass Solder-coated
Soldering Temperature	+260°C (1.5mm from case 10 sec.)

**Notes**

1. Reversed power source damages the circuit, No connection is allowed between input ground and output.
2. DO NOT operate the driver over 17W output.
3. Leave pin VADJ open if not in use, ground pin to shut down the converter. Connecting Vadj to Vin damages the circuit.
4. Maximum output open voltage is equal to input voltage.

#### Typical Operating Conditions

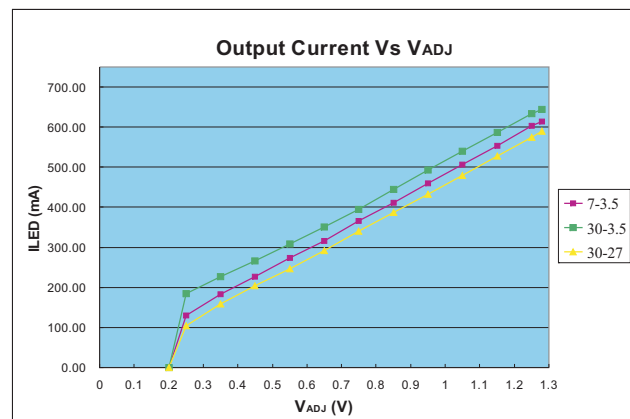
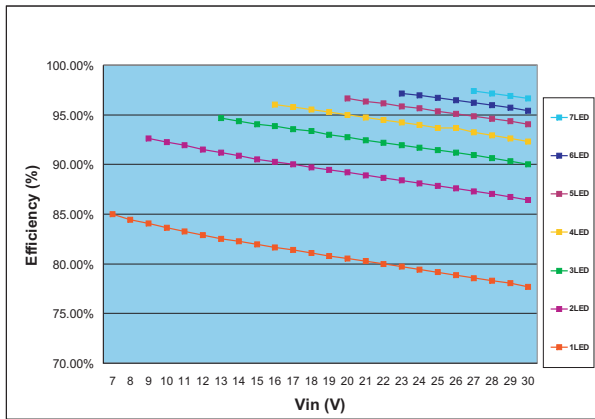
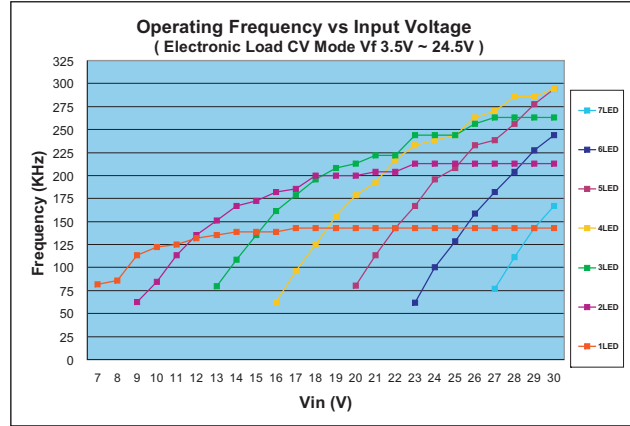
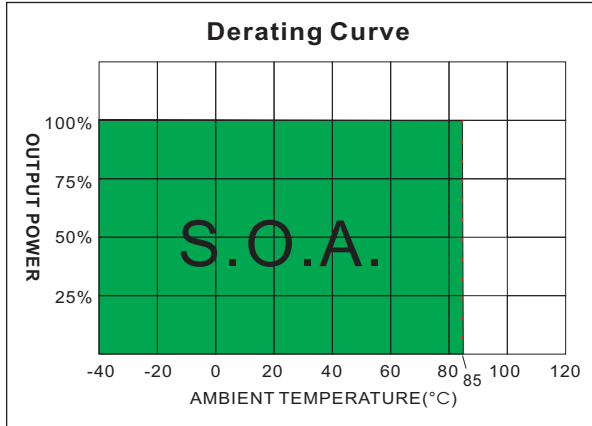

#### Recommended additional input filter

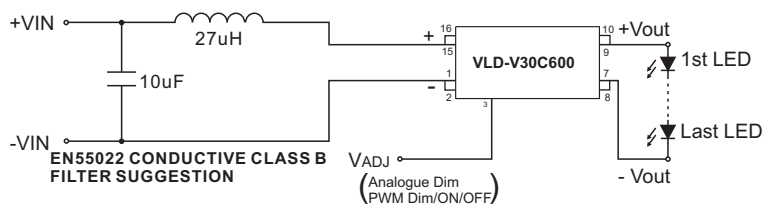

Vin=30V Vout=27V (Electronic Load CV Mode Vf 27V)

Vin=12V Vout=7V (Electronic Load CV Mode Vf 7V)

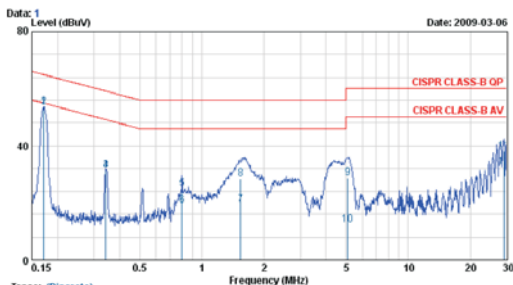

Trace: (Discrete)	Freq. MHz	LISN Factor	Cable Loss	Meter Reading	Measured Level	Limits	Over	Detector
⊕	0.171	9.80	0.06	43.42	53.28	64.90	-11.62	QP
⊕	0.171	9.80	0.06	43.70	53.56	64.90	-11.34	AVERAGE
⊕	0.343	9.88	0.05	21.56	31.49	59.13	-27.65	QP
⊕	0.343	9.88	0.05	21.36	31.29	49.13	-17.85	AVERAGE
⊕	0.800	9.90	0.04	15.03	24.97	56.00	-31.03	QP
⊕	0.800	9.90	0.04	9.25	19.19	46.00	-26.81	AVERAGE
⊕	1.543	9.96	0.05	9.31	19.32	46.00	-26.68	AVERAGE
⊕	1.543	9.96	0.05	18.34	28.35	56.00	-27.65	QP
⊕	5.085	9.83	0.25	18.69	28.77	60.00	-31.23	QP
⊕	5.085	9.83	0.25	2.17	12.25	50.00	-37.75	AVERAGE
⊕	29.061	110.08	0.30	27.75	38.13	60.00	-21.87	QP
⊕	29.061	110.08	0.30	22.28	32.66	50.00	-17.34	AVERAGE

REMARKS: 1.Level (dBuV)=Read Level (dBuV)+LISN Factor (dB)+Cable loss (dB)  
2.Over Limit value (dB)=Level (dBuV)-Limit Line (dBuV)

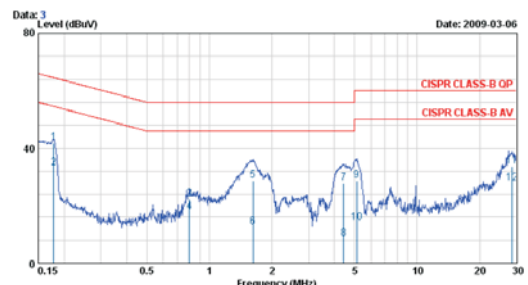

Trace: (Discrete)	Freq. MHz	LISN Factor	Cable Loss	Meter Reading	Measured Level	Limits	Over	Detector
⊕	0.178	9.80	0.06	32.08	41.94	64.59	-22.65	QP
⊕	0.178	9.80	0.06	23.13	32.99	54.59	-21.60	AVERAGE
⊕	0.800	9.90	0.04	12.41	22.35	56.00	-33.65	QP
⊕	0.800	9.90	0.04	7.82	17.76	46.00	-28.24	AVERAGE
⊕	1.619	9.97	0.05	18.81	28.83	56.00	-27.17	QP
⊕	1.619	9.97	0.05	2.59	12.61	46.00	-33.39	AVERAGE
⊕	4.430	9.81	0.18	17.86	27.85	56.00	-28.15	QP
⊕	4.430	9.81	0.18	1.61	8.38	46.00	-37.62	AVERAGE
⊕	5.112	9.83	0.26	18.58	28.66	60.00	-31.34	QP
⊕	5.112	9.83	0.26	3.87	13.95	50.00	-36.05	AVERAGE
⊕	28.755	110.08	0.32	23.42	33.82	60.00	-26.18	QP
⊕	28.755	110.08	0.32	17.46	27.36	50.00	-22.14	AVERAGE

REMARKS: 1.Level (dBuV)=Read Level (dBuV)+LISN Factor (dB)+Cable loss (dB)  
2.Over Limit value (dB)=Level (dBuV)-Limit Line (dBuV)

### Typical Application

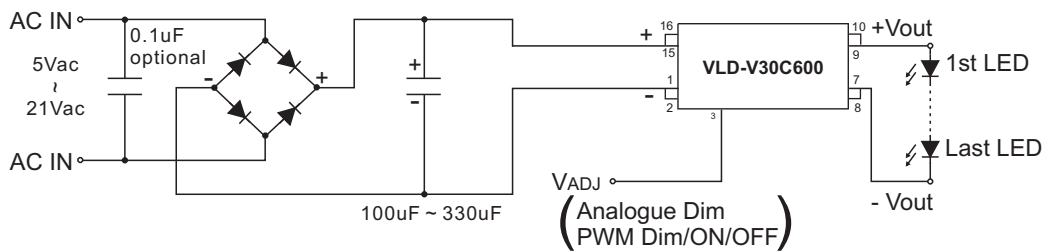
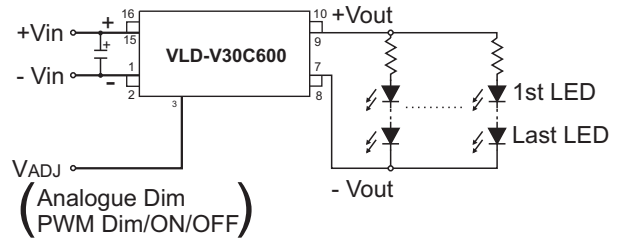
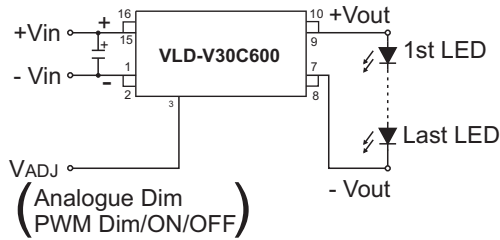

### Output Current Adjustment By External DC Control Voltage

The nominal output current is then given by:

$$I_{out} \approx \frac{0.08 \times V_{ADJ}}{0.165}$$

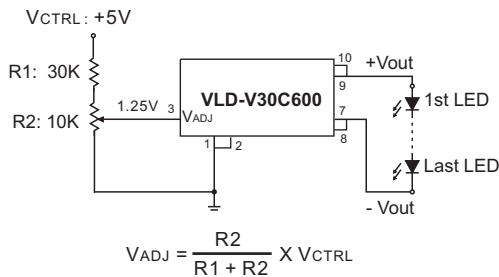
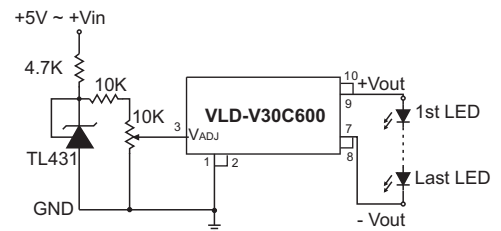
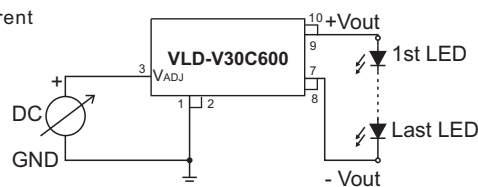

### Resistor dimming

By connecting a variable resistor between ADJ and GND, simple dimming can be achieved. Capacitor  $C_{ADJ}$  is optional for better AC mains interference and HF noise rejection. Recommend value of  $C_{ADJ}$  is 0.22uF.

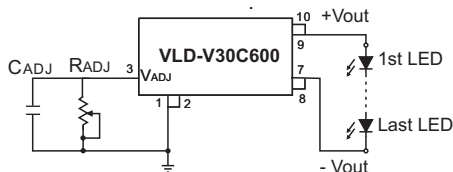

The current output can be determined using the equation:

$$I_{out} = \frac{(0.08 / 0.165) \times R_{ADJ}}{(R_{ADJ} + 200K)}$$

### Typical Application

### Output Current Adjustment By PWM Control

#### Directly driving ADJ input

A Pulse Width Modulated (PWM) signal with duty cycle  $DP_{PWM}$  can be applied to the ADJ pin, as shown below

$$I_{out} \approx \frac{0.1 DP_{PWM}}{0.165} \quad [\text{for } 0 < DP_{PWM} < 1]$$

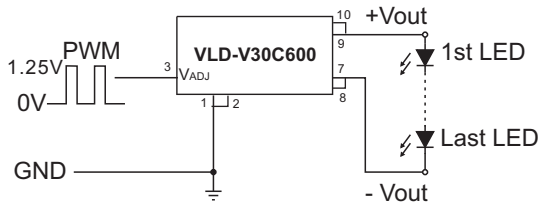

#### Driving the ADJ input via open collector transistor

The diode and resistor suppress possible high amplitude negative spikes on the ADJ input resulting from the drain-source capacitance of the transistor. Negative spikes at the input to the device should be avoided as they may cause errors in output current, or erratic device operation.

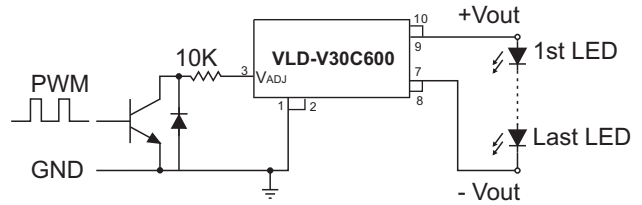

#### Driving the ADJ input from a microcontroller

Another possibility is to drive the device from the open drain output of a microcontroller. The diagram below shows one method of doing this:

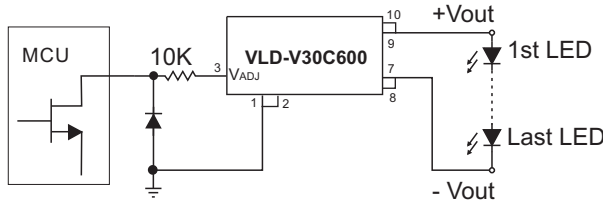

The diode and resistor suppress possible high amplitude negative spikes on the ADJ input resulting from the drain-source capacitance of the FET. Negative spikes at the input to the device should be avoided as they may cause errors in output current, or erratic device operation.

### Output Current Adjustment By PWM Control (Dimming)

To avoid visible flicker the PWM signal must be greater than 100Hz.

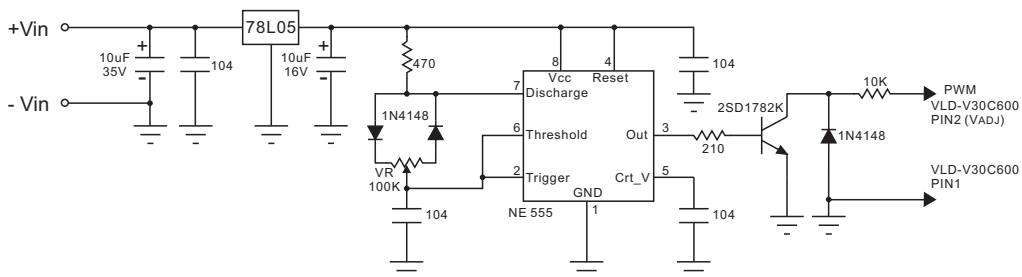

### Output Current Adjustment By PWM Control (Flash)

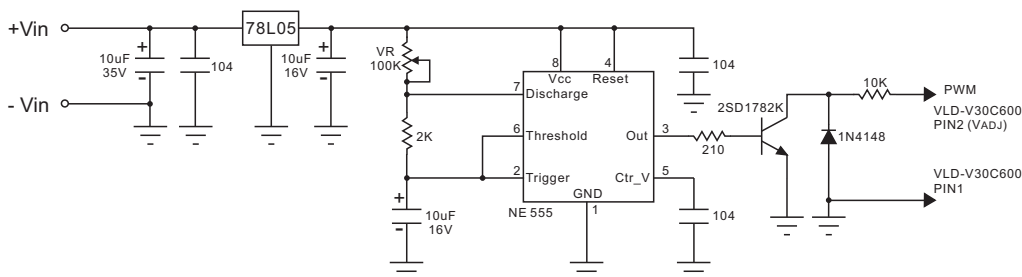

#### Typical Application

### Output Current Adjustment By External DC Control Voltage

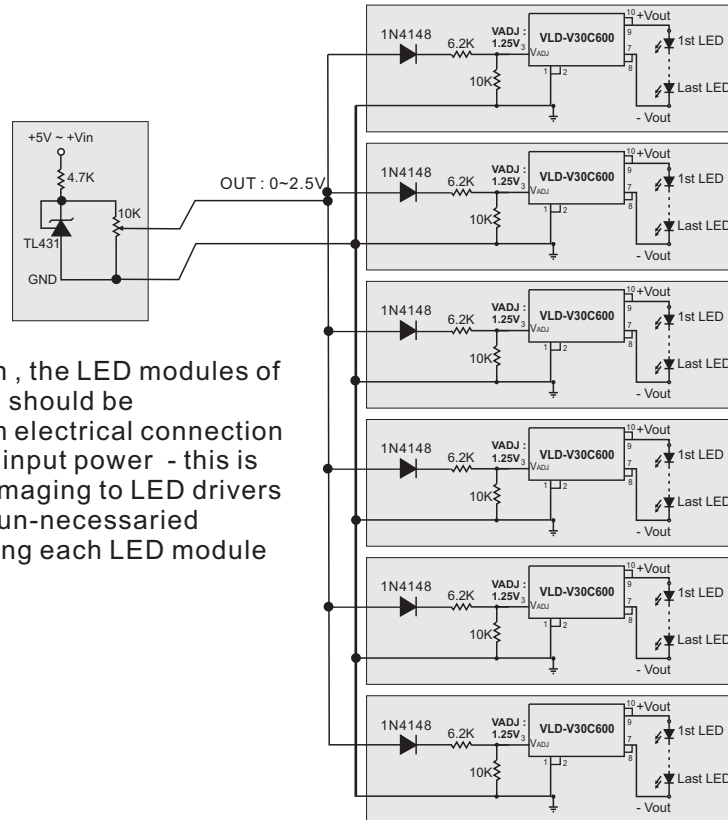

In this application, the LED modules of each LED drivers should be independent from electrical connection to the others and input power - this is to prevent the damaging to LED drivers also to avoid the un-necessaried interference among each LED module

### Thermal feedback circuit

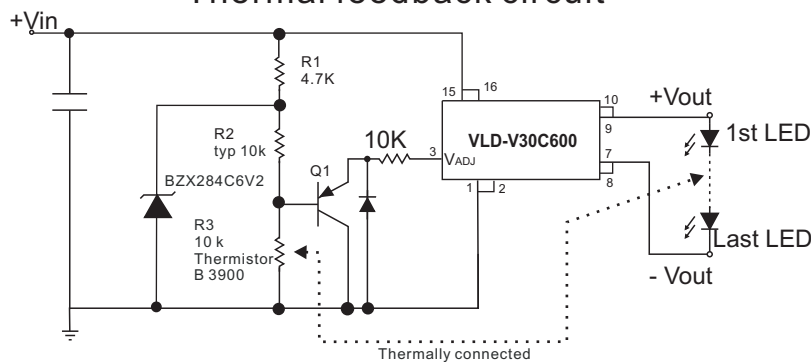

The selection of components for the thermal feedback circuit is not only dependent on the choice of R2 and R3, but also on the amount of heat sink area required to extract heat from the LEDs. To maximize the light output at high ambient or operating temperature conditions, the LEDs must have a sufficient thermal extraction path, otherwise the thermal control circuit will effect current drive reduction in non-optimal conditions. The thermal control threshold point is set by adjusting R2. For this design, three values (33k, 22k and 10k) were evaluated. These values were chosen to give break points at approximately 25°C, 40°C and 60°C. Note that the light output will not continually dim to zero - the thermal control is applying DC control to the ADJ pin and therefore has a dimming ratio from maximum Current of approximately 5:1. Once the reduced DC level goes below the shutdown threshold of around 200mV, the LED drive current will fall to zero and the LEDs will be extinguished. The slope of the current reduction is determined by the beta value of the thermistor. The larger the beta value, the sharper will be the resultant current control response. The slope of the current reduction is also affected by Q1's base emitter voltage (VBE) variation with temperature.